

Table of Contents

ECx Introduction and Set Up

- Timer Components2-5
- Sprinkler System Basics6
- Watering Program Basics7
- Watering Program Details8-9
- Planning Your Watering Schedule10
- Filling Out The Watering Schedule Form ...10-11
 - Watering Schedule Form12
- “Remote” Programming13
- Installing The Battery13
- Selecting Optional Control Features14
 - 24-Hour Clock Mode14
 - 15-Second Run Delay14
- About The Timer Memory14
- Resetting The Timer Memory15
 - To reset The Permanent Memory15
 - To Clear The Memory15

Programming The Timer

- Setting The Current Time And Day16
- Setting The Watering Day Schedule17-19
 - Setting A Calendar Schedule17
 - Setting An Interval Schedule18
 - Turning A Program Off19
- Setting Program Start Times20
- Setting Zone Run Times21

Installation

- Mounting The Timer22
- Connecting The Valves23
- Connecting A Pump Start Relay24
- Connecting The Transformer24
- Connecting A Toro Rain Switch25

Timer Operation

- **Automatic Operation**26
- **Manual Operations**27
 - Starting Programs Manually27
 - Watering Control Features28
 - ┆ To Pause Watering28
 - ┆ To Resume Watering28
 - ┆ To Cancel Watering28
 - ┆ To Skip Zones28
 - ┆ To Adjust The Zone Run Time29
- Turning Off The ECx29
- Using The Rain Delay Feature29
- Using The Season Adjust Feature30

Service and Specifications

- Replacing The Fuse31
- Adding A Zone Module32
- Troubleshooting32
- Specifications33
- Warranty Information33
- FCC Rules34

ECx Introduction and Set Up

Timer Components

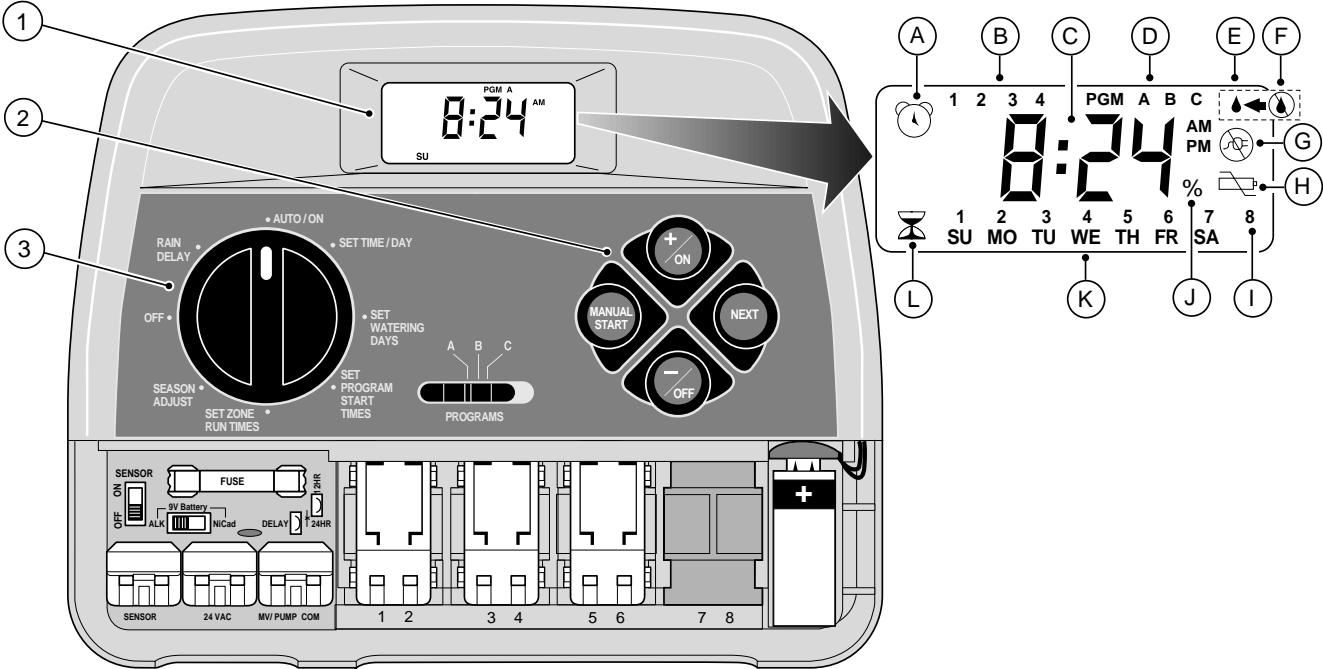

Timer Components

The following are brief descriptions of the ECx components and display elements. Each of these items will be explained in further detail within the appropriate programming, operating and installation sections of this guide.

1 - LCD Display

- A** - “Start Time” symbol – Alarm clock is displayed when setting the program start times.
- B** - Program start time identification numbers 1–4.
- C** - Main display of various time values and prompts.
- D** - Program A, B and C identifiers.
- E** - “Watering On” symbol – Water droplet indicates a watering zone is running. Droplet flashes if watering is paused.
- F** - “Watering Off” symbol – Water droplet with slash indicates all watering activity is Off.
- G** - “Power Off” symbol – Displayed when 24 VAC is disconnected and timer is on battery power only.
- H** - “Low Battery Voltage” symbol – Indicates low battery voltage (when transformer is disconnected).
- I** - Watering Zone identification numbers.
- J** - “Percent” symbol – Indicates the Season Adjust feature is in use.
- K** - Day of the week identifiers.
- L** - “Run Time” symbol – Hourglass is displayed when setting the watering zone run times.

2 - Control Buttons

+ / ON button – Increases the time display, scrolls forward through the program information and selects watering days.

- / OFF button – Decreases the time display, scrolls backward through the program information and removes watering days.

NEXT button – Advances to the next portion of program information. Resumes watering if paused. Advances through stations manually when watering.

MANUAL START button – Selects and starts manual watering operations.

3 - Control Dial – Selects all timer programming and operation controls (except Manual Start).

Control Dial Positions

AUTO / ON – Normal dial position for all automatic and manual operations.

SET TIME / DAY – Enables clock time and day to be set.

SET WATERING DAYS – Enables watering day schedules to be set and reviewed.

SET PROGRAM START TIMES – Enables program start times to be set and reviewed.

SET ZONE RUN TIMES – Enables zone run time to be set and reviewed.

(continued)

3 - Control Dial Positions (continued)

SEASON ADJUST – Selects the Season Adjust feature. See page 30 for details.

OFF – Shuts off and prevents all automatic and manual watering activity. See page 29 for details.

RAIN DELAY– Selects the Rain Delay feature. See page 31 for details.

4 - Program Select Switch – Three position slide switch used to select watering program A, B or C during the programming procedures and manual operation.

5 - Fuse – 0.75 Amp, 250V Fast Blow fuse.

6 - Sensor Bypass Switch – Controls input from the optional Toro Rain Switch (if installed). See page 25 for details.

7 - Battery Select Switch – Alkaline and NiCd position to select the type of battery installed.

8 - Sensor Connection Terminals – Snap-in connectors for optional Toro Rain Switch control wires.

9 - Transformer Connection Terminals – Snap-in connectors for the transformer wires.

10 - Pump/Master Valve Connection Terminal– Snap-in connector for the power wire from the pump start relay or master valve.

11 - Valve Common Terminal – Snap-in connector for the valve common wire.

12 - Optional 12/24-Hour Clock Feature – A small wire jumper which can be cut to select 24-hour (military time) clock mode.

13 - Optional Run Delay Feature – A small wire jumper which can be cut to select a 15-second delay period before a zone starts watering.

14 - Plug-In Zone Control Module – Each control module has snap-in connectors for two zone control valve power wires. Up to four modules can be installed.

15 - 9-Volt Battery – The battery maintains the timer memory if the transformer power is disconnected. Either an Alkaline or NiCd battery can be installed.

16 - Transformer – Supplies 24 VAC power to the timer. Plugs into a standard 120 VAC outlet. See transformer specifications on page 33.

Timer Components

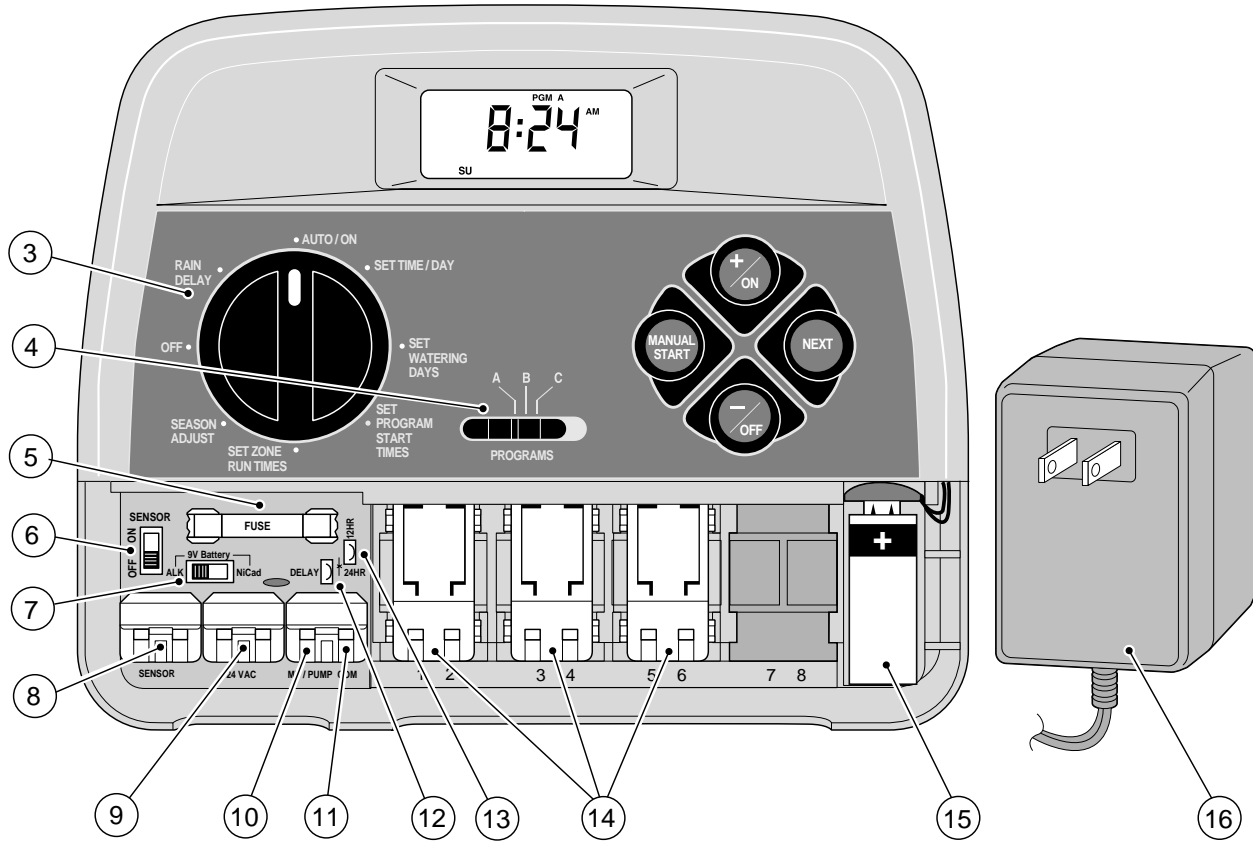

Sprinkler System Basics

The three main components of every automatic sprinkler system are the timer, zone control valves and sprinklers.

The timer is the brain of the system, telling the control valves when and how long to supply water to the sprinklers. The sprinklers direct and control the water applied to the lawn and plants.

Each valve controls a specific group of sprinklers called a watering **zone**. The zones are generally laid out and installed according to the type of plant material to be watered, the location plant within the landscape and the maximum amount of water which can be supplied. Each valve is connected to a numbered terminal within the timer, identifying it as Zone 1, Zone 2, etc.

The timer operates the valves in order, one at a time. In other words, one zone would water completely before another zone would turn on. This is called a watering **cycle**. The information stored in the timer memory which determines when and how long the zones will water is called a **program**.

The next section of this guide is very important. It explains what a program is and how the ECx controls the operation of the sprinkler system.

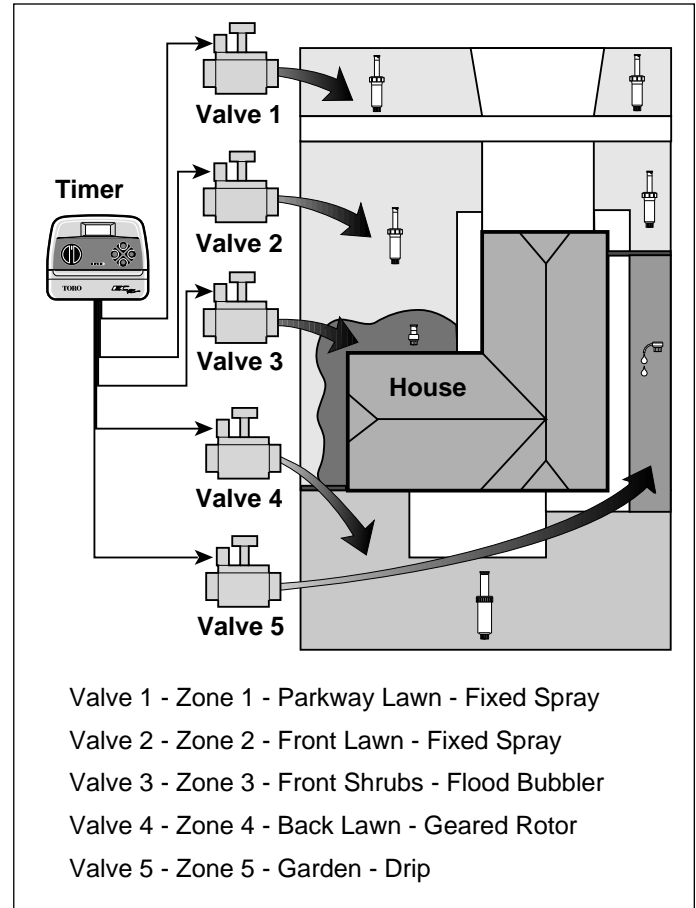

Watering Program Basics

A watering program requires three basic instructions to operate automatically:

- What days to water –called **watering days**
- When to water – called a **program start time**
- How long to water – called **zone run time**

The following example illustrates how a typical watering program could be set for the sprinkler system shown on the previous page.

Example: The program start time is set for 5:00 AM. Lawn zones 1 and 2 each have a run time of 10 minutes and lawn zone 4 is set to run for 20 minutes. Note that zones 3 and 5 water shrubs and flowers and have been excluded from this program. (These zones will be set to operate on separate programs).

As shown in the watering program diagram, at 5:00 AM the timer starts the program watering cycle. Zone 1 sprinklers run for 10 minutes and shut off. Zone 2 sprinklers turn on, run for 10 minutes and shut off. The timer skips zone 3 and turns on zone 4, which runs for 20 minutes and shuts off. Zone 5 is skipped and the watering cycle ends at 5:40 AM.

As you can see from this example, only one program start time was needed to operate three different zones.

Because of variations in plant watering needs, the ECx provides three separate programs. The programs, called **A**, **B** and **C**, are completely independent of one another – like having three timers in one housing.

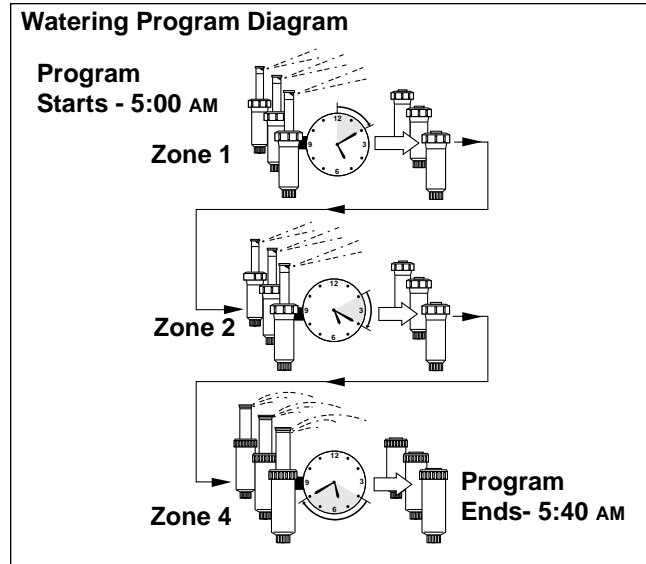

Using more than one program for example, would enable lawn zones to be watered every day on program **A**, shrub zones to run on on Monday Wednesday and Friday on program **B** and drip irrigation to soak the flower beds every three days on program **C**.

Although the ECx offers the multiple program feature, you may want to have all zones on one program if it meets your needs. The other programs can remain turned off until you need to use them.

Watering Program Details

This section covers in detail each of the three parts of a watering program – watering days, program start times and zone run times.

Selecting Watering Days

The ECx provides three options for scheduling watering days: Calendar, Interval and Off.

Calendar Schedule

A Calendar schedule enables you to select specific days of the week to water, for example, Monday, Wednesday and Friday. This is a seven-day schedule which starts on Sunday and ends on Saturday.

This illustration shows how a Calendar schedule would be displayed when the control dial is in the SET WATERING DAYS position.

In this example, program **A** has watering days set for **MO** (Monday), **WE** (Wednesday) and **FR** (Friday).

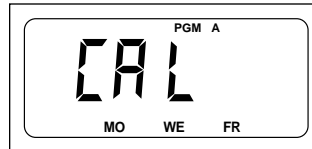

Interval Schedule

An Interval schedule enables you to set watering days without regard to the actual days of the week. For example, if you want to water every third day, you would select a 3-day Interval.

Interval schedules range from 1-day (watering every day) to 7-day (watering every seventh day). Once you have selected an Interval schedule, you can choose which day of the week will be the first day of the Interval. The number of days in the Interval determines the available start days. For example, if you have selected a 3-day Interval and today is Sunday, you may choose to start the Interval today, Monday or Tuesday.

This illustration shows how an Interval schedule would be displayed. In this example, program **B** has a 3-day Interval schedule which will start on Monday.

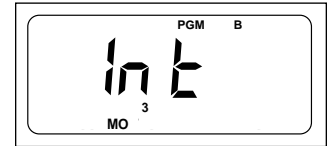

Program Off

Selecting Off suspends the operation of the program when it is not needed. Turning the program Off does not alter or erase the Calendar or Interval schedule information of the program, it simply places the program on hold until it is needed.

This illustration shows how a program would be displayed if its watering day schedule is turned Off. In this example, program **C** is Off.

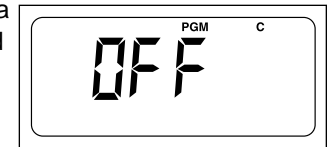

Selecting Program Start Times

A program start time is the time of day you select to begin an automatic program watering cycle.

It is important to remember that a program only requires one start time to operate automatically.

When a program starts, each zone assigned to a program will water in numerical order, one at a time for its set run time.

Sometimes it is necessary to run a watering program more than one time per day. For example, when growing a new lawn. The ECx enables each program to have up to four separate start times per day.

Program start times are numbered 1 through 4. These numbers are shown at the top left of the display next to the start time symbol  when the control dial is in the SET PROGRAM START TIMES position and indicate how many start times are currently set for the program.

This illustration shows how a program start time is displayed. In this example, program **A** has one start time (start time number 1) set for 5:00 AM.

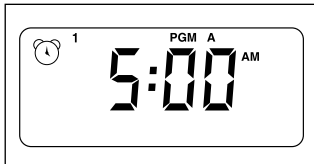

Setting The Zone Run Time

A zone run time is the length of time the zone (controlled by the valve) will water during the program watering cycle. The run time for each zone can be set from Off (no run time) to 4 hours, in one-minute increments.

A zone is **assigned** to a program when it is given a run time. If the run time for a zone is turned Off in a program, it will not operate during the program watering cycle. This is how the ECx enables you to assign watering zones to different programs.

All zones assigned to the program are shown on the lower portion of the display when the control dial is in the SET ZONE RUN TIMES position.

This illustration shows how a zone run time is displayed for a program. In this example, zones 1–6 are assigned to program **A**. Zone 1 has a 10-minute run time and zone 2 is set to run for 25 minutes.

The zone run time being displayed is identified by the flashing zone number.

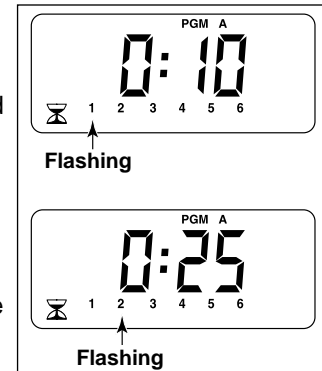

Planning Your Watering Schedule

It is always helpful to plan your watering schedule on paper before beginning the programming steps. You will have a record of your watering schedule and zone locations which can be kept with your ECx after it is installed. A watering schedule form is provided on page 12 for you to fill out.

► Guidelines For Watering

There are several factors to be considered when deciding when and how long to water. For example, the content of your soil, the part of the landscape being watered, climate conditions and the type of sprinklers being used. Because of these variables, we cannot give you an exact schedule to follow, but here are some general watering guidelines to help you get started.

- Water early in the morning, one to two hours before sunrise. You will have the best water pressure at this time and the water can soak into the plant root zone while evaporation is minimal. Watering during mid-day or in the evening may cause plant damage or mildew.
- Watch for signs of under- or over-watering and make program adjustments immediately.

Filling Out The Watering Schedule Form

When filling out this form, use a pencil so changes can be easily made. Carefully remove the page from the booklet to use as a guide during programming. After installing the timer, fold the form in half and store it in the pocket behind the timer.

Refer to the example form shown on the opposite page and fill out your form in a similar manner with the following information:

- **Location** - Identify the location of each watering zone and the type of plant being watered.
Note: Enter the following information for each program. If the program is not needed, leave its information column blank.
- **Watering Day Schedule** - For a Calendar schedule, indicate which day(s) of the week watering is desired. For an Interval schedule indicate the desired Interval number.
- **Zone Run Time** - Indicate the amount of run time (1 minute to 4 hours) for each zone. Write "Off" for any zone which you do not want to operate in the program.
- **Program Start Times** - Indicate the time of day to start the program. Each program can have 1 to 4 start times per watering day.

(Example)

Watering Schedule Form		PROGRAM A							PROGRAM B							PROGRAM C							
WATERING DAY SCHEDULE		CALENDAR							CALENDAR							CALENDAR							
		SU	MO	TU	WE	TH	FR	SA	SU	MO	TU	WE	TH	FR	SA	SU	MO	TU	WE	TH	FR	SA	
INTERVAL		1	2	3	4	5	6	7	1	2	3	4	5	6	7	1	2	3	4	5	6	7	
			X								X							X					
ZONE	LOCATION	ZONE RUN TIME							ZONE RUN TIME							ZONE RUN TIME							
1	Parkway Lawn	10							Off							Off							
2	Front Lawn	10							Off							Off							
3	Front Shrubs	Off							5							Off							
4	Back lawn	25							Off							Off							
5	Garden	Off							Off							1 hr							
6																							
7																							
8																							
PROGRAM START TIMES		1	5:00 AM							4:00 AM							6:00 AM						
		2	Off							Off							Off						
		3	Off							Off							Off						
		4	Off							Off							Off						

Watering Schedule Form		PROGRAM A							PROGRAM B							PROGRAM C							
WATERING DAY SCHEDULE		CALENDAR																					
		SU	MO	TU	WE	TH	FR	SA	SU	MO	TU	WE	TH	FR	SA	SU	MO	TU	WE	TH	FR	SA	
		INTERVAL	1	2	3	4	5	6	7	1	2	3	4	5	6	7	1	2	3	4	5	6	7
ZONE	LOCATION	ZONE RUN TIME							ZONE RUN TIME							ZONE RUN TIME							
1																							
2																							
3																							
4																							
5																							
6																							
7																							
8																							
TOTAL ZONE RUN TIME																							
PROGRAM START TIMES		1																					
		2																					
		3																					
		4																					

Selecting Optional Features

24-Hour Clock Mode

The ECx is set to display time in the 12-hour clock mode. If you prefer to use a 24-hour clock mode (military time) select this option by following the steps below.

15-Second Run Delay

The 15-second run delay feature is useful for sprinkler systems utilizing a pump or master valve. For example, a pump usually requires a few seconds to build pressure after first turning on. With the 15-second run delay selected, the pump would be running (or the master valve would open) 15 seconds before the first zone begins watering. A 15-second delay would also occur between zone operations. This helps ensure that one valve is closed before another valve opens.

Note: A 2-second run delay will occur if this option is not selected.

Caution: To prevent timer damage, ensure transformer is disconnected during this procedure.

1. Using small wire cutters, clip jumper (13) to select 24-hour clock mode. Clip jumper (12) to select 15-second run delay.

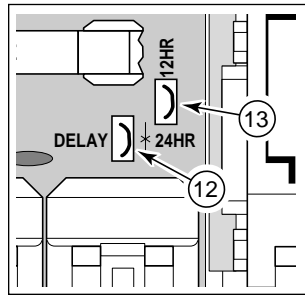

About The ECx Memory

The ECx has a permanent watering schedule within its memory to assist you in two ways. First, it will restore watering operation in case your watering program is lost due to a power interruption lasting longer than the battery life. This prevents your landscape from going unwatered if the power outage occurs while you are away.

Secondly, if you do not want to program your ECx, you may use the permanent watering schedule to operate your sprinklers. Just set the current time and day and your ECx will be ready to operate automatically.

The permanent watering schedule operates as follows: When power is applied, the timer clock is set to 12:00 AM Sunday. Program **A** has a Calendar watering schedule set to water every day. One program start time is set for 5:00 AM (5:00) and a run time of 10 minutes is set for each zone. Programs **B** and **C** are turned Off and have no program start times or run times.

Note: An optional feature is provided which enables the The ECx memory to be reset to the permanent program or cleared completely if you choose. If you do not want to use this option, skip the next procedure "Resetting The Timer Memory" and continue at page 16 to begin programming.

Resetting The Timer Memory

The ECx program memory can be reset to the permanent program values or cleared completely at any time without removing power.

Resetting the permanent program erases all user input and replaces it with the permanent program values.

Clearing the program memory sets all program values to Off (i.e., no active days, program start times or zone run times). You may find that this simplifies programming the timer if your watering requirements are quite different than the permanent values.

Note: When power is first applied, the ECx will always reset to the permanent program values.

To Reset The Permanent Program (Figure 3)

- 1 Turn the control dial to the **OFF** position. **OFF** will be displayed.
- 2 Press the **+ / ON** and **- / OFF** buttons **at the same time** until **CLR** is displayed.
- 3 Return the control dial to the **AUTO / ON** position.

To Clear The Memory (Figure 4)

- 1 Turn the control dial to the **OFF** position. **OFF** will be displayed.
- 2 Press the **+ / ON** and **- / OFF** buttons **at the same time** until **CLR 0** is displayed.
- 3 Return the control dial to the **AUTO / ON** position.

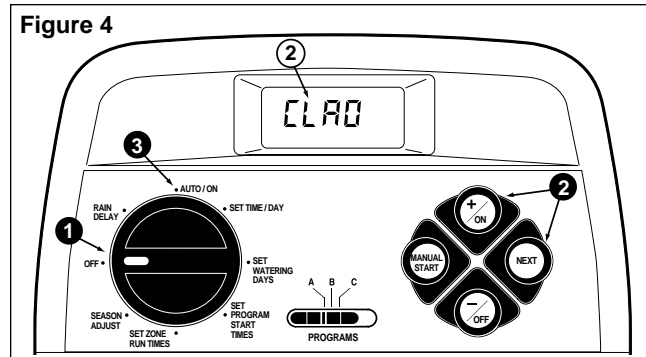
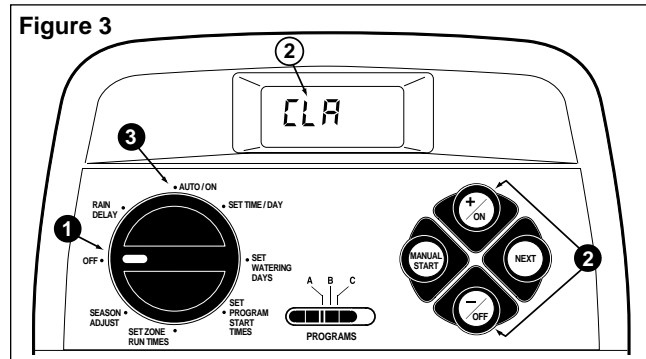

Programming The Timer

Setting The Current Time and Day

- 1 Turn the control dial to the SET TIME/DAY position. The hour digits will begin flashing.
- 2 To set the current hour (and AM/PM), press the +/ON button to scroll forward or the -/OFF button to scroll backward.
Note: The display will begin to change rapidly if either button is held down for more than two seconds.
- 3 Press the NEXT button. The minute digits will begin flashing.
- 4 To set the current minute, press the +/ON button to scroll forward or the -/OFF button to scroll backward.
- 5 Press the NEXT button. The weekday abbreviation will begin flashing.
- 6 To set the current day of the week, press the +/ON button to scroll forward or the -/OFF button to scroll backward until the current day is displayed. The weekday abbreviations are as follows:
su (Sunday) mo (Monday)
tu (Tuesday) we (Wednesday)
th (Thursday) fr (Friday) sa (Saturday)

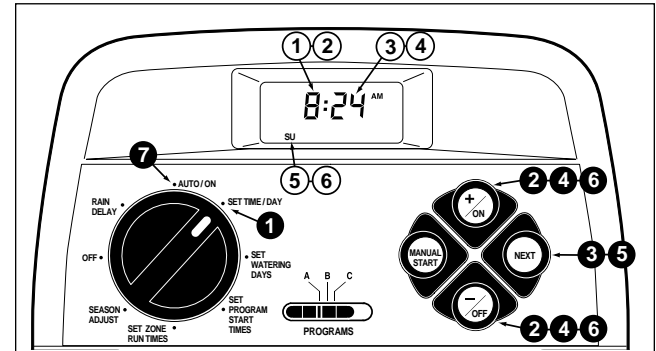

- 7 When the current time and day are displayed, return the control dial to the AUTO/ON position.

Setting The Watering Day Schedule

For each program, you can select Calendar, Interval or Off. To set a Calendar schedule, continue here. To set an Interval schedule see page 18. To turn Off a program see page 19.

Setting A Calendar Schedule

- 1 Turn the control dial to the SET WATERING DAYS position.
- 2 Check the PROGRAMS switch setting. If necessary, reposition the switch to select the desired program.
- 3 The current watering schedule will be displayed: **CAL** for Calendar, **Int** for Interval or **OFF**
 - If **CAL** is flashing, continue at step 4.
 - If **Int** or **OFF** is flashing, press the +/ON or -/OFF button to select **CAL**, then continue at step 4.
- 4 Press the NEXT button. The watering days currently set for this program will be displayed. **SU** (Sunday) will begin flashing.
- 5 To select Sunday as a watering day, press the +/ON button. To remove Sunday from the schedule, press the -/OFF button. **MO** (Monday) will now begin flashing. Continue to select or remove each day of the week until only the desired watering days are shown.

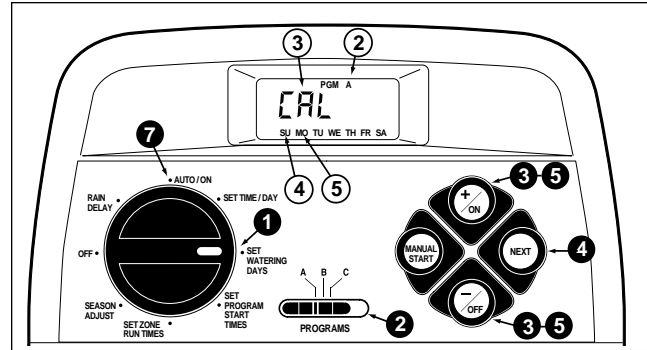

6. To set a Calendar schedule for another program, repeat all of the steps beginning at step 2.
7. When you have completed setting the Calendar schedule for each program (as needed) return the control dial to the AUTO/ON position.

Setting An Interval Schedule

- 1 Turn the control dial to the SET WATERING DAYS position.
- 2 Check the PROGRAMS switch setting. If necessary, reposition the switch to select the desired program.
- 3 The current watering schedule will be displayed:
CAL for Calendar, **Int** for Interval or **OFF**.
 - If **CAL** or **OFF** is displayed, press the +/ON or -/OFF button to select **Int**, then continue at step 4.
 - If **Int** is displayed, continue at step 4.
- 4 Press the NEXT button. The current Interval number (1–7) will begin flashing. The day of the week on which the Interval will start will be shown.
- 5 To change the Interval number, press the +/ON or -/OFF button until the desired number is flashing.
- 6 Press the NEXT button. The Interval start day will begin flashing.
- 7 To change the Interval start day, press the +/ON button or the -/OFF button until the desired day is flashing.
8. To set an Interval schedule for another program, repeat all of the steps beginning at step 2.

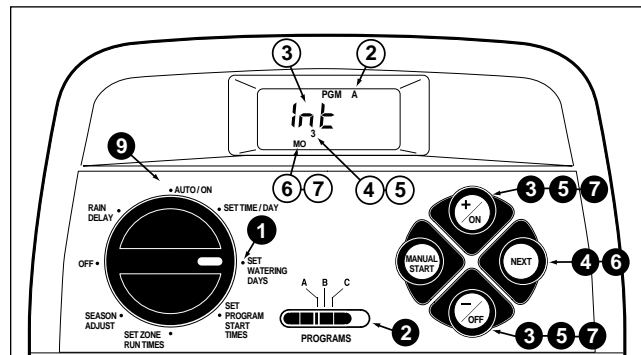

- 9 When you have completed setting the Interval schedule for each program (as needed) return the control dial to the AUTO/ON position.

Turning Off A Program

Note: Selecting the Off setting does not alter or erase the Calendar or Interval schedule of the program, it simply places the program on hold until the Calendar or Interval schedule is reselected.

- 1 Turn the control dial to the SET WATERING DAYS position.
- 2 Check the PROGRAMS switch setting. If necessary, reposition the switch to select the desired program.
- 3 The current watering schedule will be displayed: **CAL** for Calendar, **Int** for Interval. Press the +/ON or -/OFF until **OFF** is flashing.
4. To turn another program Off, repeat steps 2 and 3 as needed.
- 5 Return the control dial to the AUTO/ON position.

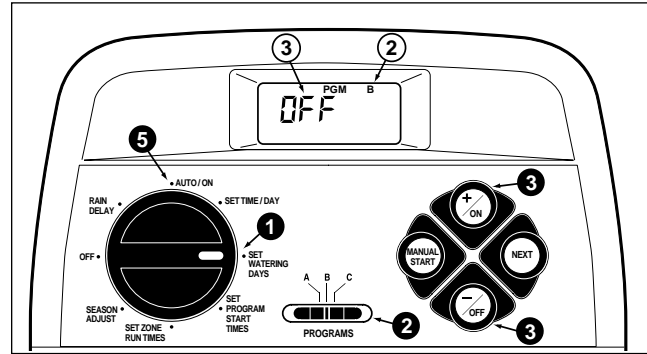

Setting Program Start Times

- 1 Turn the control dial to the SET PROGRAM START TIMES position.
- 2 Check the PROGRAMS switch setting. If necessary, reposition the switch to select the desired program.
- 3 Program start time number 1 will begin flashing. The current program start time or OFF will be displayed for start time number 1. To select a different program start time number, press the +/ON or the -/OFF button until the desired number is flashing.
- 4 Press the NEXT button. The hour digit(s) or OFF will begin flashing.

Note: To remove the start time, select **OFF** by pressing the +/ON and -/OFF buttons at the same time, and continue at step 8.

- 5 To set the hour (and AM/PM), press the +/ON or the -/OFF button until the desired hour is flashing.
- 6 Press the NEXT button. The minute digits will begin flashing.
- 7 To set the minutes, press the +/ON or -/OFF button until the desired minute is flashing.
- 8 Press the NEXT button. The next program start time number will begin flashing.

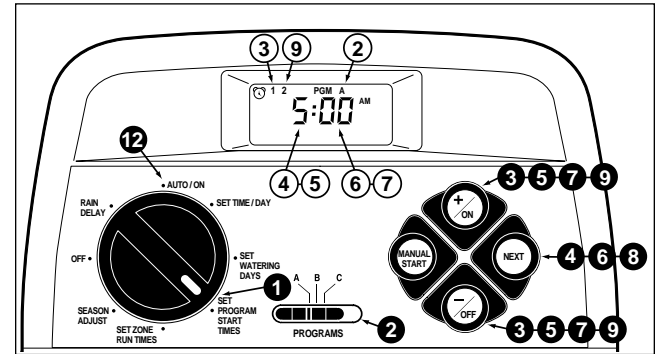

- 9 To select another start time number, press the +/ON or the -/OFF button until the desired start time number is flashing.
10. To set, change or remove a program start time for the start time number selected, repeat all of the steps starting at step 4.
11. To set program start times for another program, repeat all of the steps starting at step 2.
- 12 Return the control dial to the AUTO/ON position.

Setting Zone Run Times

- 1 Turn the control dial to the SET ZONE RUN TIMES position.
- 2 Check the PROGRAMS switch setting. If necessary, reposition the switch to select the desired program.
- 3 Zone number 1 will be flashing and its current run time or OFF will be shown. To select a different zone number, press the +/ON or the -/OFF button until the desired zone number is flashing.
- 4 Press the NEXT button. The run time (or OFF) will begin flashing.
- 5 To set the run time, press the +/ON or the -/OFF button until the desired run time is shown.

Note: To remove the run time, select OFF by pressing the +/ON and -/OFF buttons **at the same time**.

- 6 Press the NEXT button. The next zone number will begin flashing.
7. Repeat steps 5 and 6 as needed to set, change, or remove the run time for the remaining zones.
8. To set the zone run time for another program, repeat all of the steps starting at step 2.
- 9 Return the control dial to the AUTO/ON position.

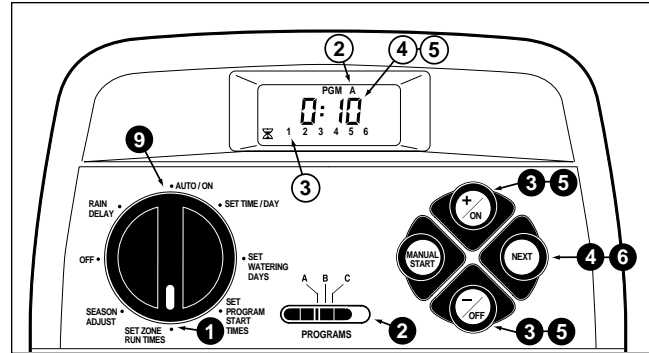

Installation

Note: The ECx timer is not weather resistant and must be installed indoors or in a protected area. For outdoor installation, an optional weather-resistant outdoor cabinet (model # 53335) is available.

Mounting The Timer

1. Select a location for the timer within 4' (1.2m) of an electrical outlet to enable the transformer wires to easily reach. Make sure the outlet is not controlled by a light switch.
2. Remove the mounting bracket attached to the back of the timer housing by pulling the lower edge of the bracket away and downward from the timer housing.
3. Place the mounting bracket (A) against the wall aligning the top edge at about eye level. Drive three 1" (25mm) wood screws (B) into the wall through the three holes provided in the bracket.

Note: If you are installing the bracket on drywall or masonry, install screw anchors (C) to prevent screws from loosening.

4. Align the slotted openings on the back of timer housing with the mounting bracket tabs. Slide the timer downward to engage the tabs.

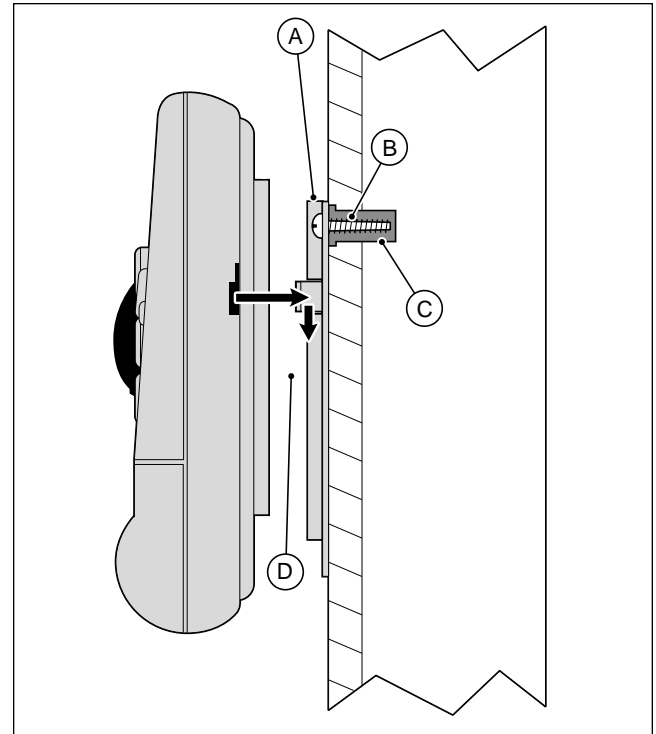

Note: Store the Quick Reference Guide and the Watering Schedule Form in the pocket (D) between the timer and bracket.

Connecting The Valves

1. Route the valve control wires between the valves and the timer.

Note: Using 18 AWG (0.75 mm²) multi-wire sprinkler valve connection cable is recommended. This cable is insulated for direct burial and is color-coded to simplify installation.

2. Attach the white color-coded wire from the cable to one wire from each valve solenoid. (Either solenoid wire can be used for this connection.) This is called the **valve common** wire.
3. Attach a separate cable wire to the remaining wire from each valve solenoid. Make a note of the wire color code used for each valve and the watering zone it controls. You will need to have this information when connecting the valve wires to the timer.
4. Use screw-on wire fasteners to secure each wire connection. Waterproof all connections with grease caps or similar insulation method.
5. Route the wire cable into the timer. Strip insulation back 1/2" (13mm) from all cable wires.

Note: The ECx has snap-in wire terminals. To attach wires, simply raise the lever, insert the stripped wire, and press the lever down to secure.

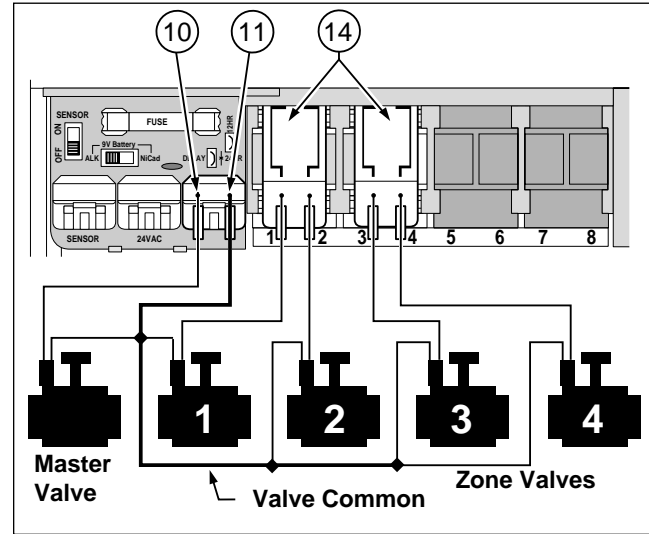

6. Referring to the Timer Components on page 5 and the diagram above, secure the valve common wire to the terminal labeled COM (11). Connect the individual zone valve wires to the appropriate zone module terminals (14). Connect the master valve wire (if applicable) to the terminal labeled PUMP/MV (10).

Note: Connecting a master valve (or pump relay) is optional and may not be required in your sprinkler system.

Connecting A Pump Start Relay

(Optional)

Caution: To prevent timer damage, ensure the relay current draw does not exceed 0.35 Amps. Do not connect the timer directly to the pump starter.

1. Route a wire pair from the pump relay into the timer housing
2. Connect one wire to the terminal labeled COM (11). Connect the remaining wire to the terminal labeled PUMP/MV (10) as shown below.

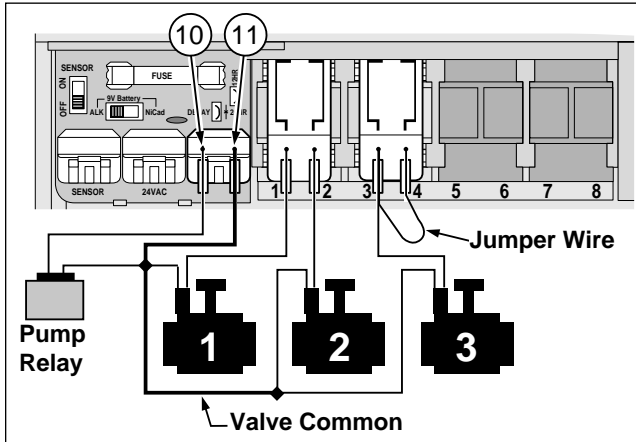

Caution: To prevent pump damage due to “dead-heading”, connect a jumper wire from any unused zone terminal to a zone terminal with a valve connected.

Connecting The Transformer

Caution: Do not plug the transformer into an electrical outlet until all of the wiring procedures have been completed.

1. Ensure the transformer is unplugged.
2. Connect one transformer cable wire to each terminal labeled 24 VAC (9). The wires can be connected to either terminal.

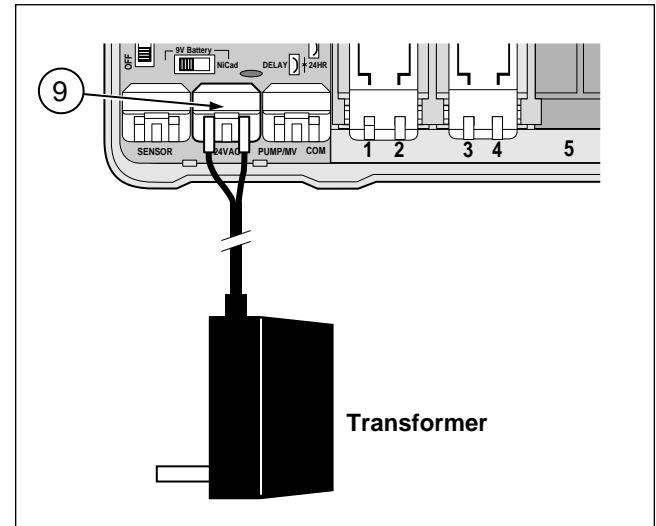

Connecting A Toro Rain Switch

(Optional)

The Toro Rain Switch (model # 53221) is a remote rain sensing device which can be connected directly to your ECx to automatically interrupt watering during rain.

A sensor bypass switch is provided in the ECx which enables the Rain Switch operation to be turned On and Off.

When the Rain Switch absorbs rain water it automatically signals the ECx to suspend all watering operations. The “No Watering” symbol  will appear in the upper right corner of the display until the Rain Switch dries out and automatically resets. The “No Watering” symbol will disappear and timer operation will resume as programmed.

1. Route the wire cable from Toro Rain Switch into the timer housing with the valve wires.
2. The Rain Switch cable has four wires: two copper wires and two silver wires. Only two of the wires are used. Connect the heavier 18 AWG (0.75mm²) copper wire and the thin 24 AWG (0.50mm²) silver wire to the terminals labeled SENSOR (8). Trim off the remaining two cable wires.
3. Set Sensor Switch (6) as required: ON allows the Rain Switch to interrupt watering; OFF bypasses the Rain Switch input.

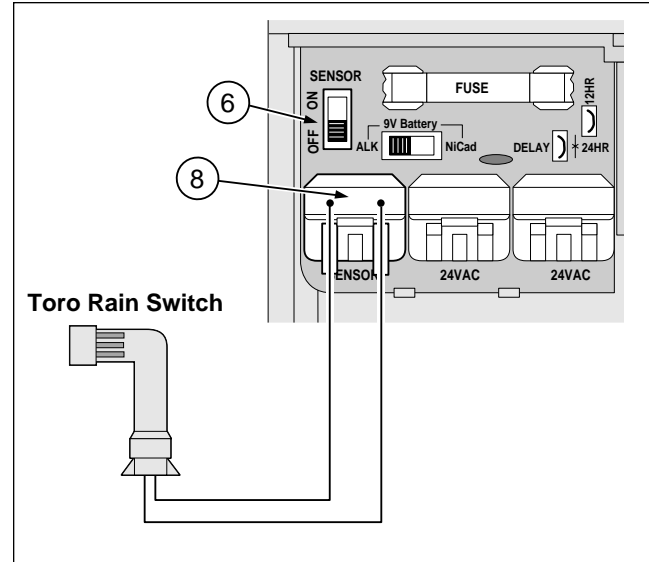

Timer Operation

The ECx timer has three modes of operation: Automatic, Manual and Off. In the Automatic mode the timer tracks the time and day and operates the automatic watering schedules. The Manual mode enables the watering programs to be started and controlled manually at any time. The Off mode shuts off all watering activity and prevents any zones from operating automatically or manually.

The Rain Delay and Season Adjust control features are provided to enable quick, temporary changes in operation to help compensate for variables in weather and season.

Each of the operating modes and control features are explained in this section of the guide and can be found on the following pages:

- Automatic Operation, page 26
- Manual Operations, page 27 & 28
- Turning Off The ECx, page 29
- Using the Rain Delay Feature, page 29
- Using the Season Adjust Feature, page 30

Automatic Operation

In the Automatic mode, the ECx keeps track of the current time, day of the week and the automatic watering program schedule. Automatic operation will occur whenever a programmed watering day and start time match the current time and day.

The Automatic mode is selected when the control dial is in the AUTO/ON position. While in the automatic mode, the display will show two types of information: status and operation.

This illustration shows the status display. In this example the current time is 2:45 PM and the current day is Monday. Programs **A** and **B** are active on Monday.

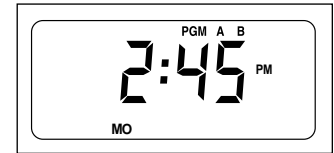

When watering starts, the operating display appears and is shown for the duration of the program.

In this example, program **A** is operating. Zone 1 is watering and has 10 minutes of run time remaining. Zones 2, 3 and 4 will operate during this program.

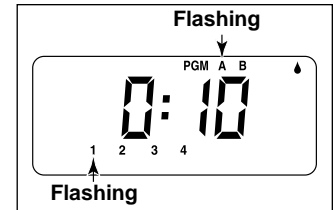

Note: If the control dial remains in any other position (except OFF) for more than 8 minutes, the timer reverts to the Automatic mode.

The PROGRAMS switch is not functional in the Automatic Mode.

Watering Control Features

The following watering control features enable you to further control the watering program during operation.

All watering control features apply to watering programs started manually **and** automatically.

To Pause Watering

Press the **+ / ON** and **- / OFF** buttons **at the same time**.

- The zone currently watering will shut off.
- The “Watering On” symbol will begin flashing.
- The display will show the amount of run time remaining for the paused zone.

Note: If watering is not resumed within 8 minutes, all watering operations will be canceled and the timer will return to the automatic mode.

To Resume Watering (when paused)

Press the **NEXT** button.

- Watering activity will resume from the point of interruption.

To Cancel Watering

Press the **+ / ON** and **- / OFF** buttons **at the same time - two times**.

- All watering operations will be canceled and the timer will return to the automatic mode.

Note: Placing the control dial in the **OFF** position for two seconds, then back to **AUTO / ON** will also cancel all watering operations.

To Skip Zones

Press the **NEXT** button one time.

- The zone currently watering will shut off and the next zone will start.
- If the last zone is skipped, the program will end. If additional programs have been set to operate the next program in alphabetical order will start.

To Adjust The Zone Run Time

Press the **+ / ON** button to increase run time or the **- / OFF** button to decrease run time.

- If the zone run time is decreased to less than 1 minute, the zone will shut off. The next zone in sequence will start.
- The zone run time is changed during this operation only. The program memory will not be changed.

Turning Off The ECx

When the control dial is turned to the OFF position, the timer immediately shuts off any watering operation currently in progress. Leaving the control dial in the OFF position will prevent all automatic and manual watering operations. The timer will continue to track the current time and day of the week.

For extended shutdown of the sprinkler system leave the control dial in the OFF position.

The word OFF will be displayed for 8 minutes. The automatic status display will then appear with the “No Watering” symbol as shown in this illustration.

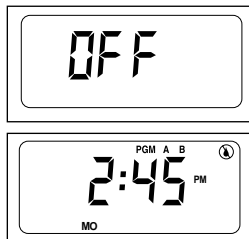

Automatic operation is resumed by turning the control dial to the AUTO/ON position.

Using The Rain Delay Feature

This feature enables all watering operations to be delayed from 1 to 7 days. For example, rain is forecast in your area for the next two days. Instead of turning the timer off (and possibly forgetting to turn it back on), a rain delay of 3 days can be easily entered. At the end of 3 days, the timer will resume automatic operation as scheduled.

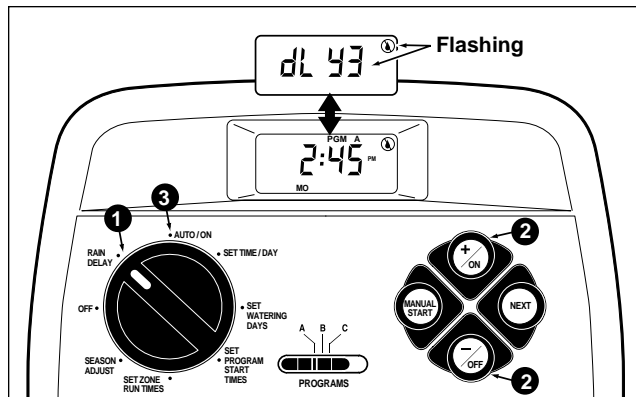

- 1 Turn the control dial to the RAIN DELAY position. The rain delay display will begin alternating with the automatic status display.
- 2 To set the number of rain delay days, press the +/ON or -/OFF button until the desired number (1–7) is flashing.
- 3 Return the control dial the control to the AUTO/ON position.

Note: The rain delay number will automatically decrease as each day passes. When the number reaches 0 (zero), automatic operation will resume at the next scheduled start time.

To cancel the rain delay, turn the control dial momentarily (3 seconds) to the OFF position.

Using The Season Adjust Feature

Changes in season and temperature generally require a change in zone run time to maintain a healthy landscape and conserve water. The season adjust feature enables you to change the run time of all zones assigned to a program, simultaneously up or down, in 10% increments – with just the press of a button. Adjustments can be reduced to 10% or increased to 200% of the programmed run time of each zone.

A 50% setting, for example, would decrease a 20-minute zone run time to 10 minutes. Increases however, work a little differently. With any adjustment above 100%, the ECx will first increase the run time by the adjustment percentage, then split the time in half and run the watering program twice. This allows the water to soak-in instead of pooling or running off. For example, adjusting to 150% would first increase a 20-minute zone run time to 30 minutes, then split the time in half and run two watering cycles back-to-back with 15 minutes in each operation. During operation the % symbol will flash to indicate a multiple watering operation.

Note: All zone run times are retained in the timer memory and returned to their set value when the season adjust is reset to 100%. The only time a zone run time will appear changed is during operation.

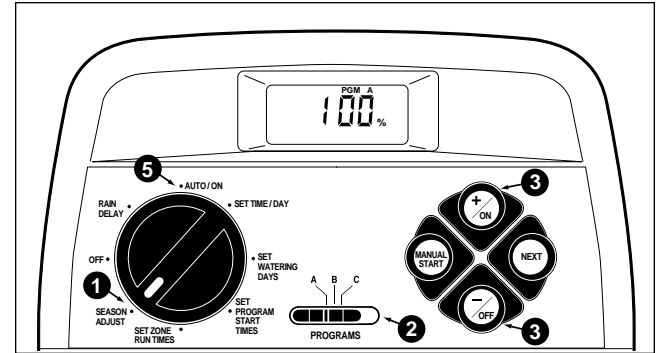

- 1 Turn the control dial to the SEASON ADJUST position. The season adjust display will be shown and 100% will be flashing.
- 2 Check the PROGRAMS switch setting. If necessary, reposition the switch to select the desired program.
- 3 Press the +/ON or -/OFF until the desired adjustment value is flashing.
4. To apply the Season Adjust feature to another program, repeat steps 2 and 3.
- 5 Return the control dial the AUTO/ON position.

Service and Specifications

Replacing The Fuse

A 0.75 Amp fuse protects the timer from damage due to power surges and excessive current draw through the Zone Modules. Before replacing the fuse, check for the probable cause, such as a shorted or improperly connected control valve wire, then replace the fuse as follows:

1. Unplug the transformer from the wall receptacle.



WARNING
REMOVE TRANSFORMER FROM POWER SOURCE PRIOR TO SERVICING THE FUSE. FAILURE TO COMPLY MAY RESULT IN INJURY AND/OR DAMAGE TO TIMER.

2. Remove the lower front cover from the timer housing by sliding it downward.
3. Carefully remove the blown fuse from the retaining clip.
4. Remove the replacement fuse from the back side of lower cover and install it into fuse retaining clip.
CAUTION: Never install a higher amperage fuse! Severe damage to the timer can result.
5. Install the lower front cover.
6. Plug the transformer into the wall receptacle.

Adding A Zone Module

1. Turn the control dial to the OFF position.
2. Remove the lower front cover from the timer housing by sliding it downward.

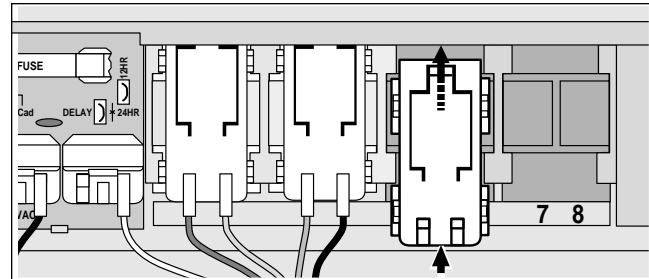

3. Place the back of the zone module squarely between the guides of the first open expansion slot (from left to right). Pushing lightly on the bottom of the module, slide it upward until it locks into position.
4. To connect the valve wires, refer to “Connecting The Valves” on page 23.
5. Install the lower front cover.
6. To set the zone run time, refer to “Setting Zone Run Times” on page 21.
7. To test the operation of the new watering zone(s), refer to “Manual Operations” on pages 27 and 28.

Troubleshooting

If you are having a problem with the timer, check the following symptoms, possible causes and remedies. If the problem cannot be resolved or you would like assistance with any Toro irrigation product, call our toll-free **Toro Help Line**, 1-800-367-8676 Monday through Friday, 7:30 AM – 4:00 PM (Pacific Standard Time)

Symptom	Possible Cause	Remedy
The display is blank and the timer does not operate.	<p>The battery is dead and one or more of the following causes:</p> <p>Blown fuse.</p> <p>Transformer wires disconnected or the transformer is unplugged.</p> <p>Open circuit breaker to wall plug receptacle.</p>	<p>Replace the battery and one or more of the following:</p> <p>Replace the fuse. See page 31.</p> <p>Check the transformer connections.</p> <p>Check circuit breaker at service.</p>
Watering programs start at unscheduled times.	Watering programs have overlapping schedules.	Shorten zone run times and/or space start times farther apart.
Watering zone does not turn on.	<p>Faulty control valve wire connections.</p> <p>Zone run time is turned Off.</p>	<p>Check the wire connections at the control valve and controller.</p> <p>Enter a zone run time. See page 21.</p>
Watering zone does not turn off.	Control valve problem.	Inspect, clean and/or replace the valve solenoid.
Program restarts unexpectedly after the completion of an automatic operation.	<p>More than one start time on the program.</p> <p>Season Adjust setting greater than 100%.</p>	<p>Remove additional program start times. See page 22.</p> <p>Set Season Adjust to 100%. See page 32.</p>

Specifications

Transformer: Plug-In Class 2, UL Listed, CSA Certified

Input: 120 VAC 50/60 Hz

Output: 24 VAC 50/60 Hz; 0.75 Amps

Fuse: 0.75 Amp, Fast Blow – Protects AC Return

Maximum Load Per Zone:

0.35 Amps @ 24 VAC @ 140° F

Maximum Load For Pump/Master Valve:

0.35 Amps @ 24 VAC @ 140° F

Total Maximum Output: 1 Zone plus Pump,
not to exceed 0.70 Amps @ 24 VAC @ 140° F

Battery Type and Back-Up Duration:

9-Volt Alkaline – 72 hrs. or 9-Volt NiCad – 24 hrs.

Recommended Control Valve Wire Size:

18 AWG (0.75 mm²)

Housing: Plastic, indoor, wall mount,

8" W x 8" H x 2" D (20cm W x 20cm H x 5cm D)

Warranty

The Toro Promise – Limited One Year Warranty

The Toro Company warrants, to the owner, each new piece of equipment (featured in the current catalog at date of installation) against defects in material and workmanship provided they are used for irrigation purposes under manufacturer's recommended specifications for the period described below. Product failures due to acts of God (i.e., lightning, flooding, etc.) are not covered by this warranty.

Toro is not liable for failure of products not manufactured by Toro even though such products may be sold or used in conjunction with Toro products.

During such warranty period, Toro will repair or replace, at its option, any part found to be defective. Toro's liability is limited solely to the replacement or repair of defective parts. All other express and implied warranties are specifically disclaimed.

Return the defective part to the place of purchase.

This warranty does not apply where equipment is used, or installation is performed, in any manner contrary to Toro's specifications and instructions, nor where equipment is altered or modified.

Toro is not liable for indirect, incidental or consequential damages in connection with the use of equipment, including but not limited to: vegetation loss, the cost of substitute equipment or services required during periods of malfunction or resulting non-use, property damage or personal injury resulting from installer's actions, whether negligent or otherwise.

All implied warranties, including those of merchantability and fitness for use, are limited to the duration of this express warranty.

This warranty gives you specific legal rights and you may have other rights which vary from state to state.

FCC Rules

Note: This equipment has been tested and found to comply with the limits for a Class B digital device, pursuant to Part 15 of the FCC Rules. These limits are designed to provide reasonable protection against harmful interference in a residential installation. This equipment generates, uses and can radiate radio frequency energy and, if not installed and used in accordance with the instructions, may cause harmful interference to radio communications. However, there is no guarantee that interference will not occur in a particular installation. If this equipment does harmful interference to radio or television reception, which can be determined by turning the equipment off and on, the user is encouraged to try to correct the interference by one or more of the following measures:

1. Reorient or relocate the receiving antenna.
2. Increase the separation between the equipment and receiver.
3. Connect the equipment into an outlet on a circuit different from that to which the receiver is connected.
4. Consult the dealer or an experienced radio/TV technician for help.

The user may find the following booklet prepared by the Federal Communications Commission helpful:

“How To Identify and Resolve Radio-TV Interference Problems”. This booklet is available from the U.S. Government Printing Office, Washington, DC 20402. Stock No. 004-000-00345-4.

